

10  1x

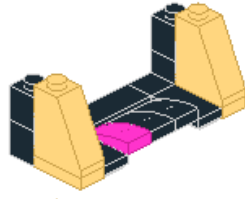

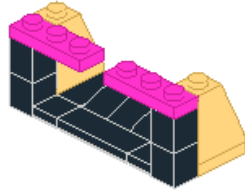

11  2x

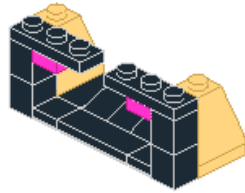

12  2x

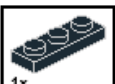

13  1x
 1x

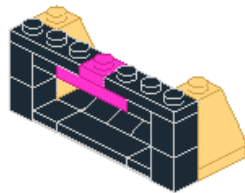

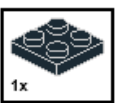
14  1x

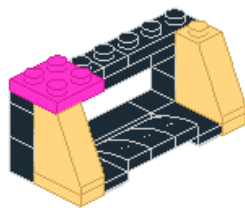

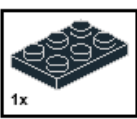
15  1x

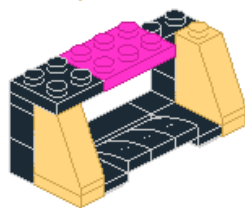

16  1x

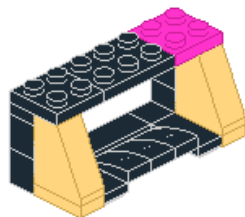

17  2x



18  2x

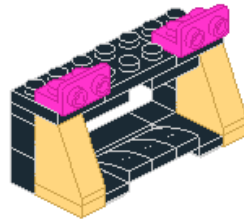

19  2x

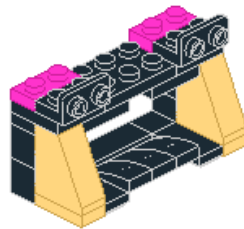

20  2x

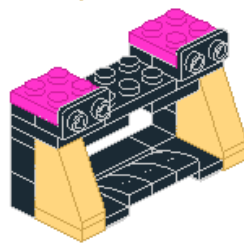

21  2x

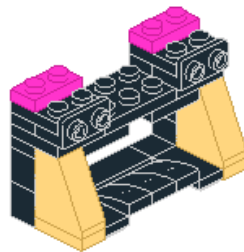

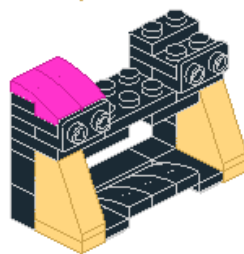

22  2x

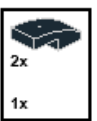

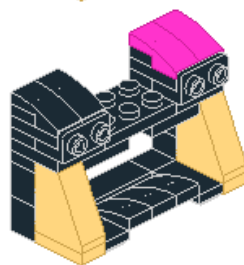
23  2x
1x



24  1x

25  1x

26  1x

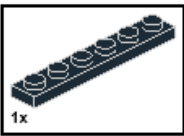
27  1x

28  1x

29  2x

30  5x

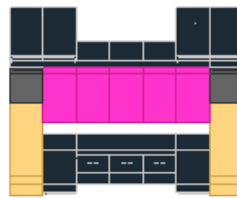
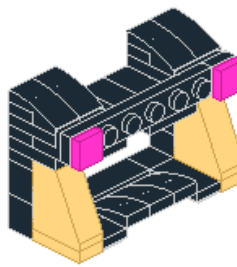
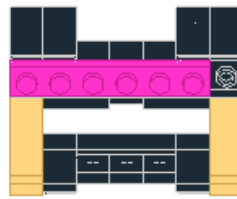
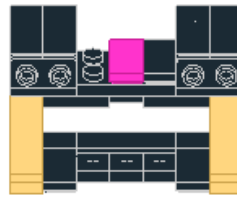

31[□]

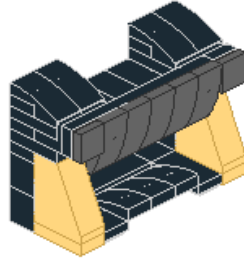

32

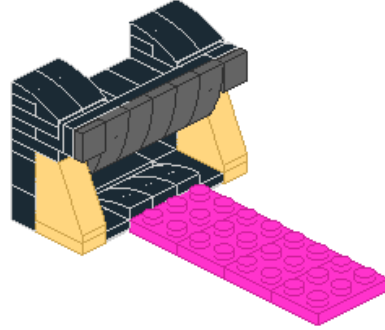
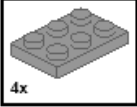

33

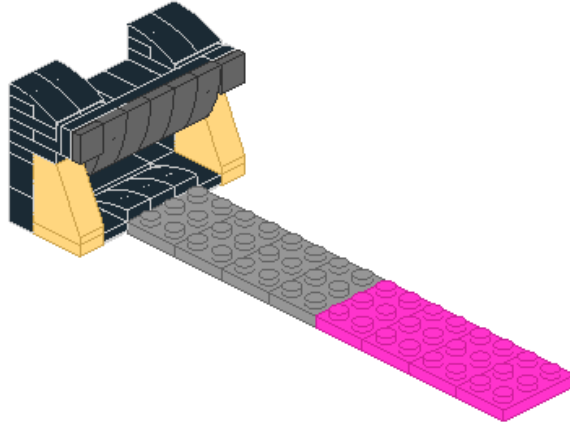
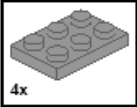

34

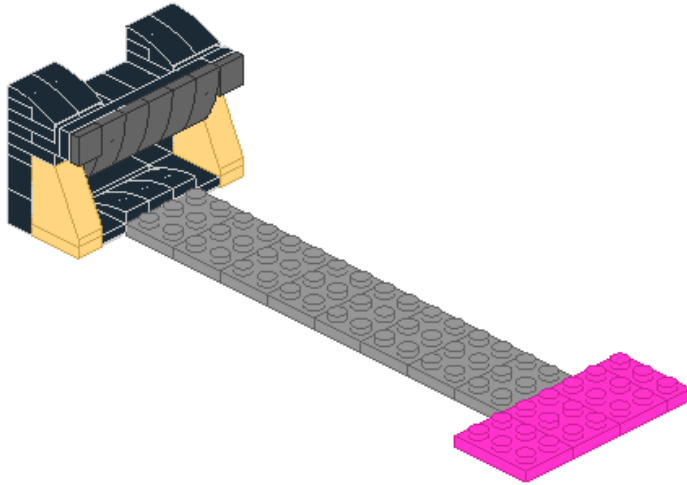
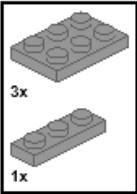

35

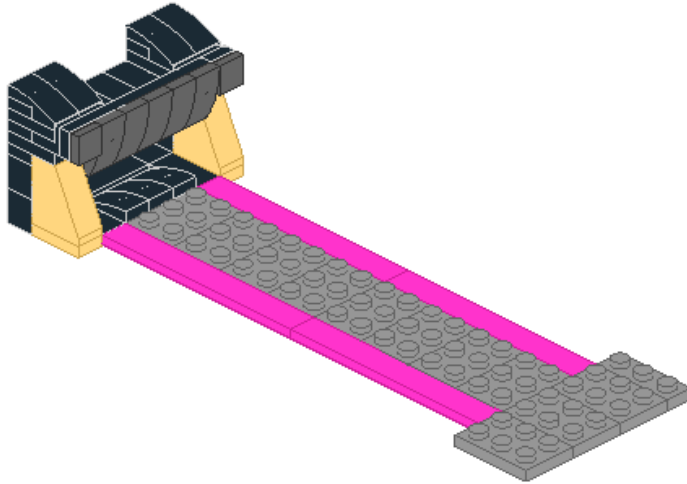

36

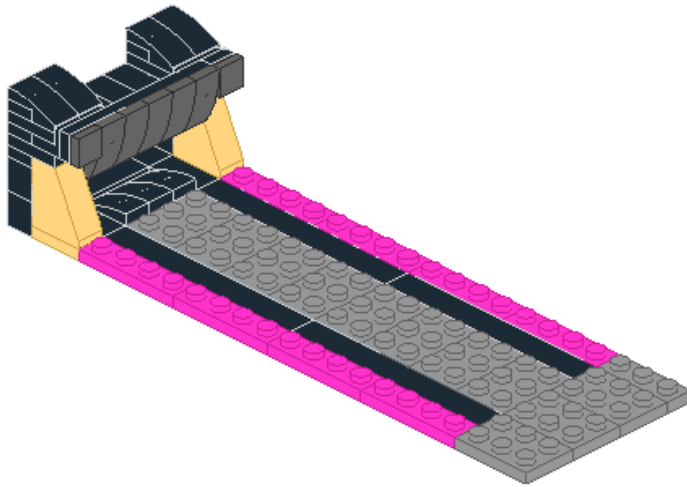
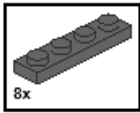

37

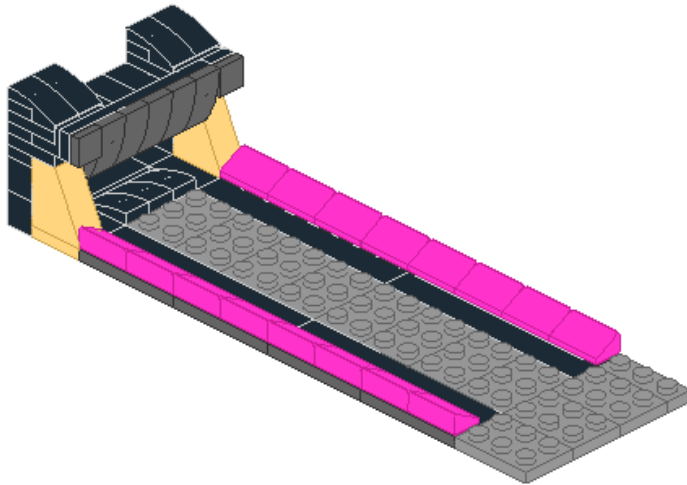

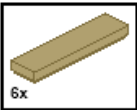
38  6x

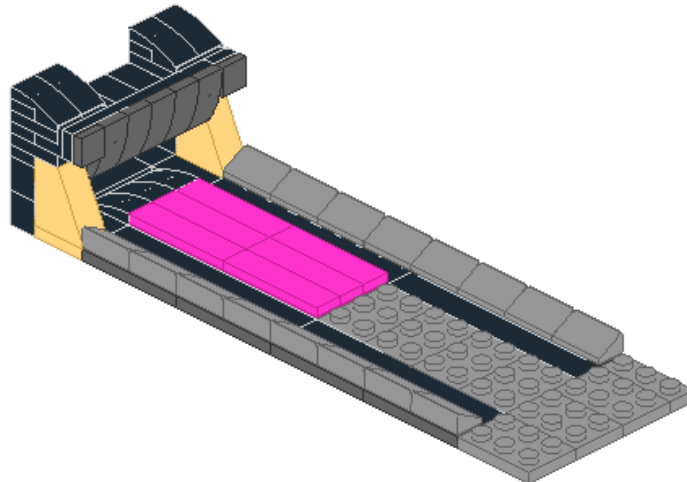

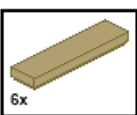
39  6x

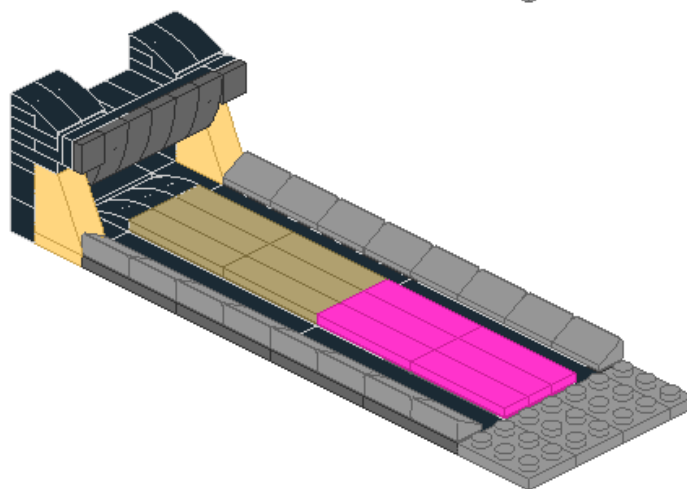

40  11x

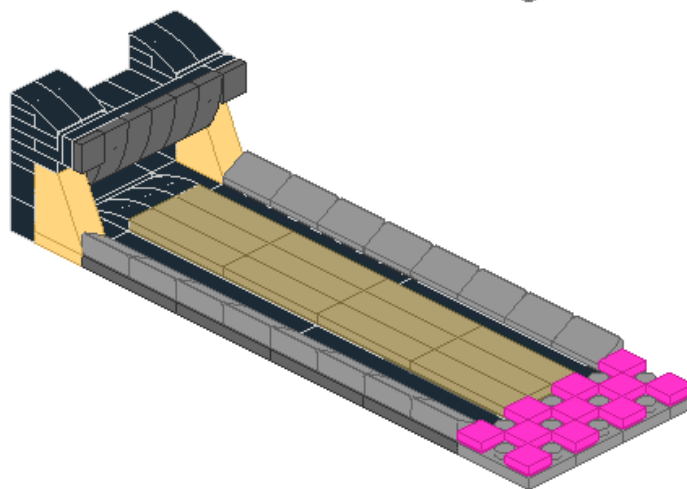

41  10x

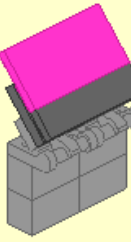
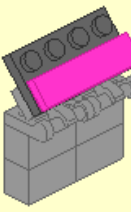
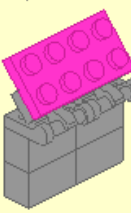
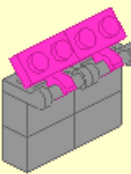
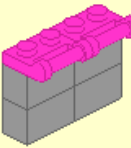
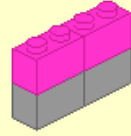
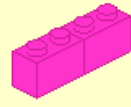
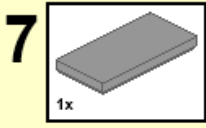
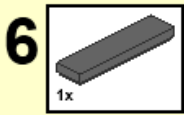
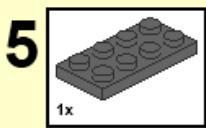
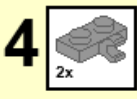
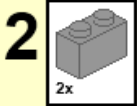
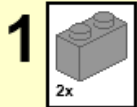
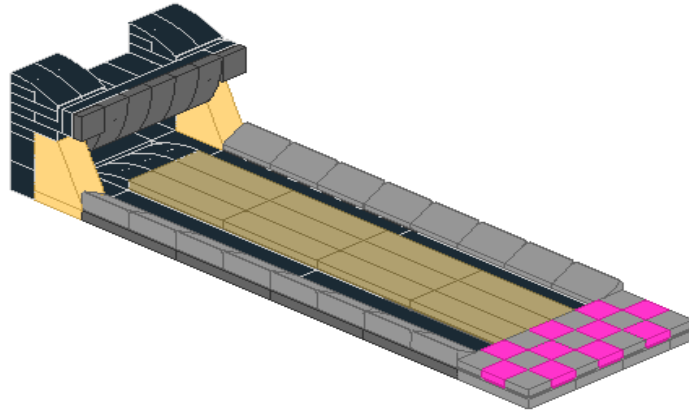

42

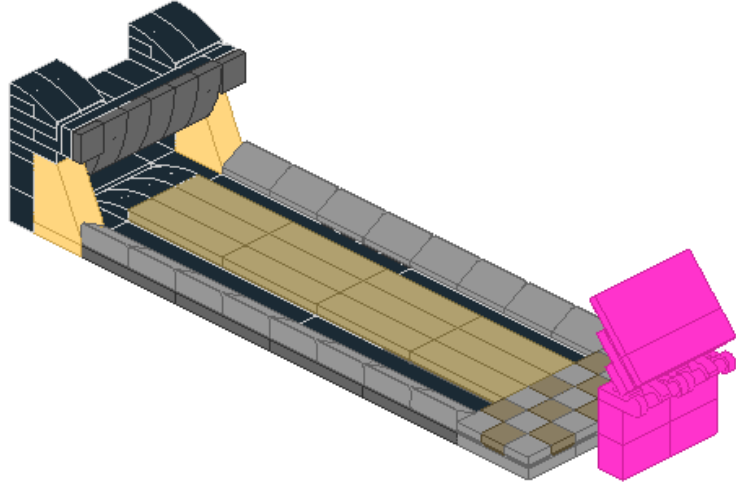
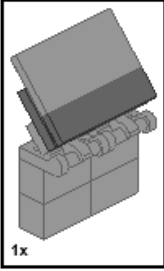

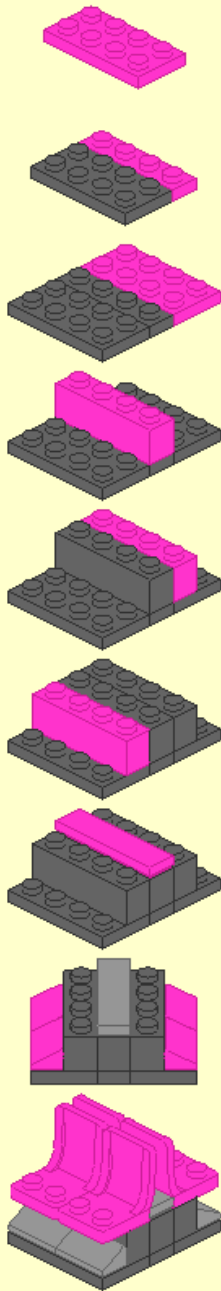
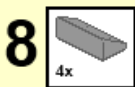
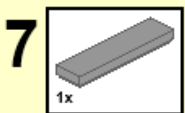
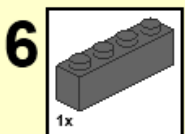
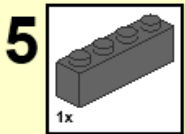
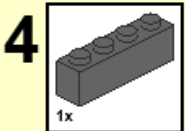
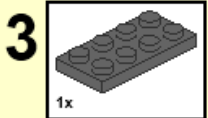
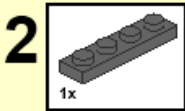
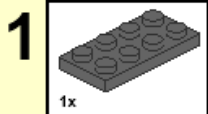

43

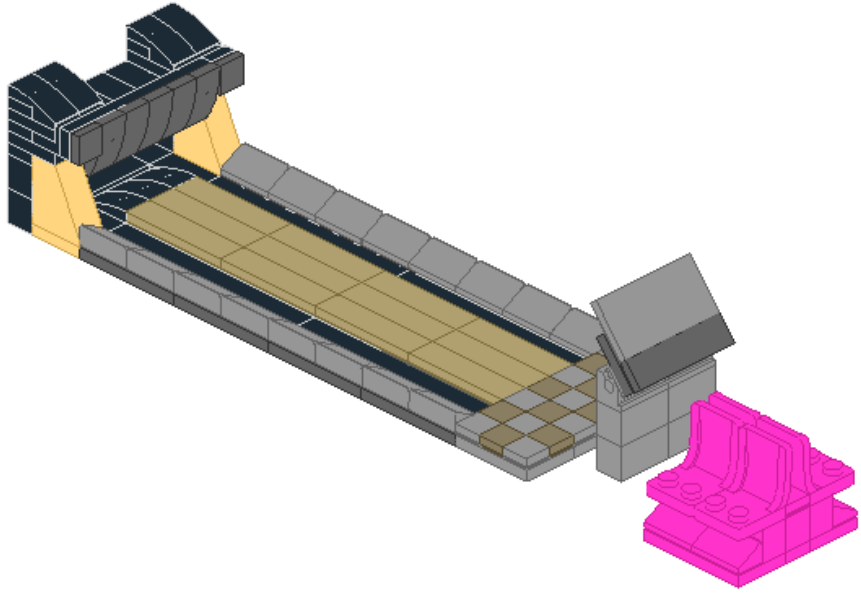
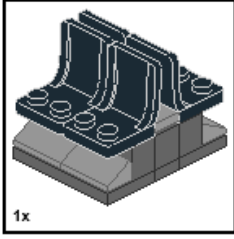

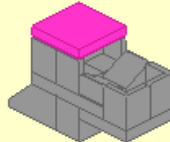
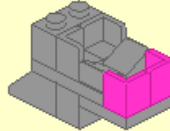
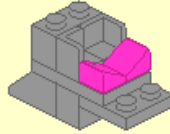
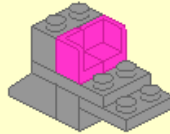
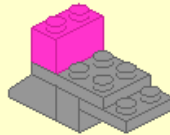
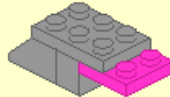
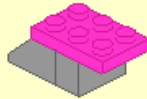
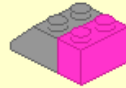
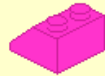
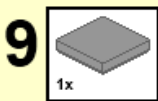
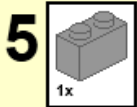
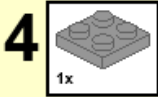
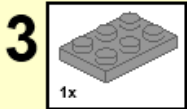
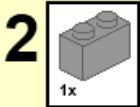
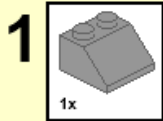

44

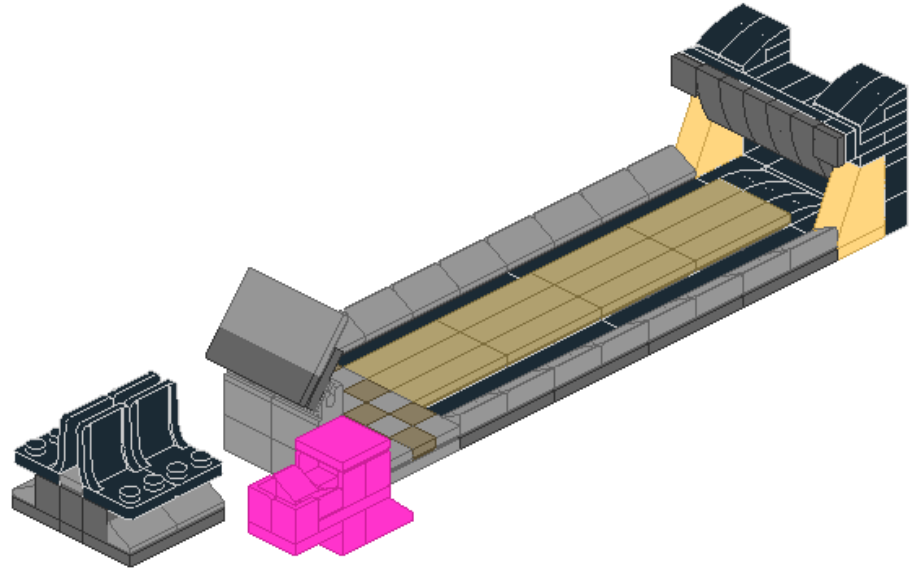
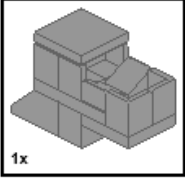

1

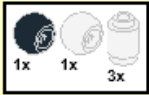

2[□]



45

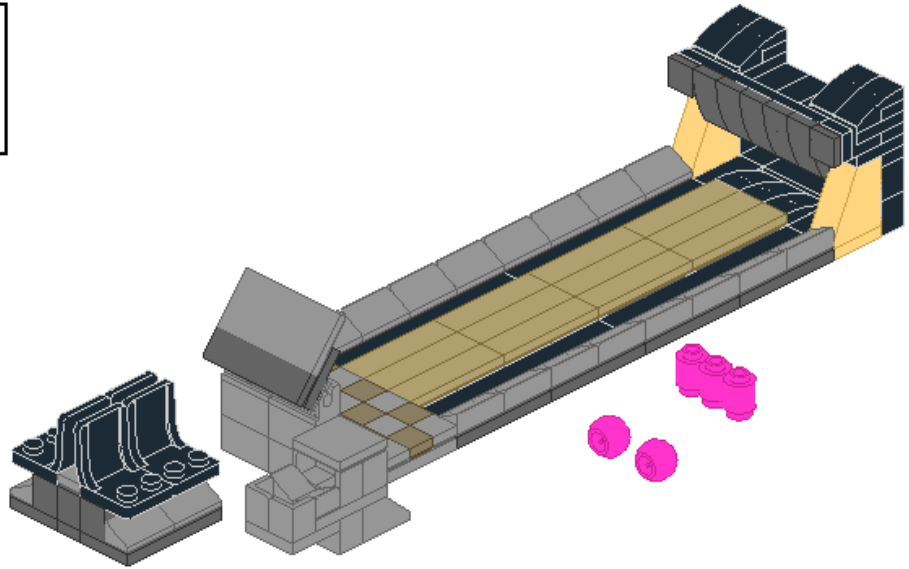

46[□]

